

Bajonett - Einsteck-Thermoelemente

Bayonet lock - push in - thermocouples

Thermocouples avec fixation à baïonnette

T81

• Anwendung

Für den Einsatz im allgemeinen Maschinen-, Apparate-, Behälter- und Rohrleitungsbausowie in der Chemie-Verfahrenstechnik und im Lebensmittelbereich sehr gut geeignet.

• Service intended

These rugged thermometers are well suited for machine and apparatus engineering, pressure vessels and piping as well as for environments in chemical process and food industry.

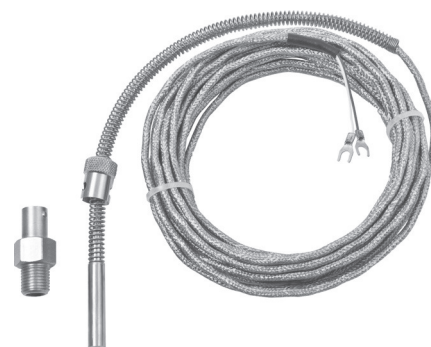

• Utilisation

Ces thermomètres sont très bien adaptés aux utilisations dans la construction de machines, d'appareils, de tuyauterie et réservoirs ainsi que dans la chimie, technologie des procédés industriels et dans l'industrie alimentaire.



Technische Daten	Technical Data	Caractéristiques techniques
Schutzart IP 65 nach EN 60529	Protection class IP 65 per EN 60529	Degré de protection IP 65 selon EN 60529
Einsatzrohr Edelstahl 1.4571 Ø 6 mm / Ø 8 mm	Stem Stainless steel 316Ti 6 / 8 mm dia.	Gaine de protection Acier inox Z6 CNDT 17-12 Ø 6 mm / Ø 8 mm
Einbautiefe ca. 30 bis 150 mm	Instalation depth ca. 30-150 mm	Profondeur de montage ca. 30 bis 150 mm
Bajonettkappe Messing vernickelt, Innen- Ø 12,7 mm / Ø 14,6 mm	Bayonet fixing Brass, nickel-plated Inner dia. 12,7 mm / 14,6 mm	Fixation à baïonnette Laiton, nickelé, Intérieur Ø 12,7 mm / Ø 14,6 mm
Bajonett-Gegenstück siehe Seite 11.0703	Bayonet sockets see page 11.0703	Contre-pièce de fixation à baïonnette voir page 11.0703
Druckfeder rostfreier Edelstahl	Compression spring Stainless steel	Ressort spiral Acier inox
Anschlussleitung Glasseide-isolierte Litzenleiter Querschnitt: 0,35 mm ² Armierung aus verzinkten Stahldrähten	Cable length Braid wire, glass silk insulated Profile: 0,35 mm ² Steel-plated	Encablure Isolation, Câble à Soie de verre Coupe transversale: 0,35 mm ² Ferrailage, grillage métallique
Messorgan Thermopaar nach DIN 43710 / DIN EN 60584 1x Fe-) 1x Fe-CuNi Typ (L) 1x NiCr-Ni Typ (K)	Temperature element Thermocouple per DIN 43710 / DIN EN 60584 1x Fe-CuNi Typ (J) 1x Fe-CuNi Typ (L) 1x NiCr-Ni Typ (K)	Sonde Thermocouple selon DIN 43710 / DIN EN 60584 1x Fe-CuNi Typ (J) 1x Fe-CuNi Typ (L) 1x NiCr-Ni Typ (K)
Temperaturbereich Maximal +400°C	Temperature range Maximum +400°C	Plage de températures Maximal +400°C
Genauigkeitsklasse Klasse 2 nach DIN 43710 / DIN EN 60584 ± 2,5°C	Accuracy class Class 2 per DIN 43710 / DIN EN 60584 ± 2,5°C	Tolérance classe A selon DIN 43710 / DIN EN 60584 ± 2,5°C

Stand: 6. 03. 2019

 Ergänzungen	 Optional extras	 Options
siehe Seite 11.0703 - 11.0704	see page 11.0703 - 11.0704	voir page 11.0703 - 11.0704
Technische Informationen siehe ab Seite 19.0401	Technical information see from page 19.0401	Informations techniques voir à partir de la page 19.0401

T81

Bajonett - Einsteck-Thermoelemente Bayonet lock - push in - thermocouples Thermocouples avec fixation à baïonnette

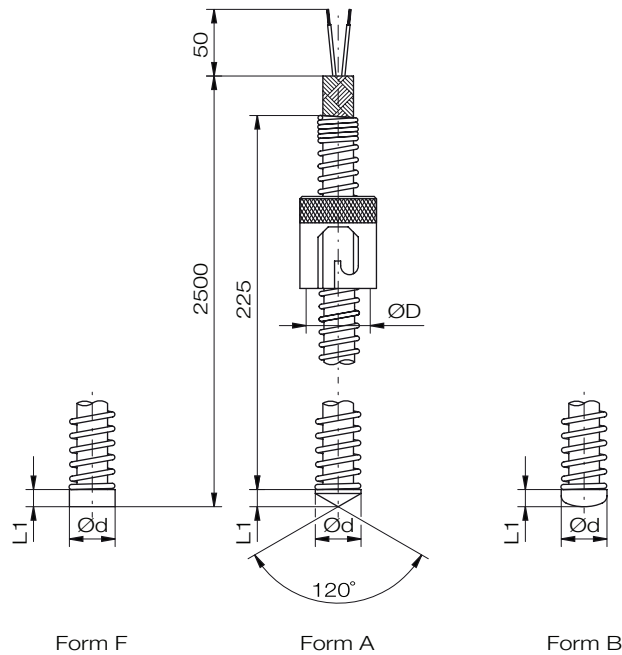

ØD	Ød mm	L1	Form	Thermoelement Thermocouples Élément thermocouple	Bestell-Nr. Order-N° N° de commande	Bestellbeispiel ordering exampel préciser à la commande
12	6	3	F	1 x Fe-CuNi Typ (J)	119403	<p>T81. F. 6. 3. 2,5m</p> <p>Kabellänge Kable length Encablure</p> <p>L1</p> <p>Ø</p> <p>Form, form, forme</p> <p>Thermoelement Thermocouples</p>
				1 x Fe-CuNi Typ (L)	119361	
				1 x Ni-CrNi Typ (K)	119657	
				2 x Fe-CuNi Typ (J)	119585	
				2 x Fe-CuNi Typ (L)	119621	
				2 x Ni-CrNi Typ (K)	119693	
			A	1 x Fe-CuNi Typ (J)	119415	
				1 x Fe-CuNi Typ (L)	119362	
				1 x Ni-CrNi Typ (K)	119669	
				2 x Fe-CuNi Typ (J)	119597	
				2 x Fe-CuNi Typ (L)	119633	
				2 x Ni-CrNi Typ (K)	119705	
			B	1 x Fe-CuNi Typ (J)	119427	
				1 x Fe-CuNi Typ (L)	119363	
				1 x Ni-CrNi Typ (K)	119681	
				2 x Fe-CuNi Typ (J)	119609	
				2 x Fe-CuNi Typ (L)	119645	
				2 x Ni-CrNi Typ (K)	119717	
15	8	3	F	1 x Fe-CuNi Typ (J)	119409	
				1 x Fe-CuNi Typ (L)	119364	
				1 x Ni-CrNi Typ (K)	119663	
				2 x Fe-CuNi Typ (J)	119591	
				2 x Fe-CuNi Typ (L)	119627	
				2 x Ni-CrNi Typ (K)	119699	
			A	1 x Fe-CuNi Typ (J)	119421	
				1 x Fe-CuNi Typ (L)	119365	
				1 x Ni-CrNi Typ (K)	119675	
				2 x Fe-CuNi Typ (J)	119603	
				2 x Fe-CuNi Typ (L)	119639	
				2 x Ni-CrNi Typ (K)	119711	
			B	1 x Fe-CuNi Typ (J)	119433	
				1 x Fe-CuNi Typ (L)	119366	
				1 x Ni-CrNi Typ (K)	119687	
				2 x Fe-CuNi Typ (J)	119615	
				2 x Fe-CuNi Typ (L)	119651	
				2 x Ni-CrNi Typ (K)	119723	

Stand: 6. 03. 2019

Bajonett Gegenstück für Einsteck-Thermoelemente
Bayonet sockets lock - push in - thermocouples
Contre-pièce de fixation à baïonnette pour Thermocouples

T81

Form A	Bajonett-Gegenstück Bayonet socket Contre-pièce de baïonnette			
	ØD mm	d2 mm	G	Bestell-Nr. Order N° N° de commande
	12	6,5	M12 x 1	414195
	15			414196
	12	8,5		414197
	15			414198
	12	6,5	G1/4B	414199
	15			414200
	12	8,5	414201	
	15		414202	

Form B	Bajonett-Gegenstück Bayonet socket Contre-pièce de baïonnette			
	ØD mm	d2 mm	G	Bestell-Nr. Order N° N° de commande
	12	6,5	M12 x 1	414203
	15			414204
	12	8,5		414205
	15			414206
	12	6,5	G1/4B	414207
	15			414208
	12	8,5	414209	
	15		414210	

Form C	Bajonett-Gegenstück Bayonet socket Contre-pièce de baïonnette			
	ØD mm	d2 mm	G	Bestell-Nr. Order N° N° de commande
	12	6,5	M12 x 1	414211
	15			414212
	12	8,5		414213
	15			414214
	12	6,5	G1/4B	414215
	15			414216
	12	8,5	414217	
	15		414218	

Stand: 6. 03. 2019

Adernendhülse
sleeve
embout

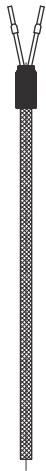

Bestell-Nr.
Order-N°.
N° de commande

396457

Steckverbinder EN61515
connector
connecteur



Bestell-Nr.
Order-N°.
N° de commande

396458

Lemosa
Buchse
socket
prise de courant

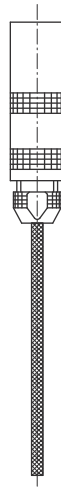

Bestell-Nr.
Order-N°.
N° de commande

396461

Lemosa
Stecker
connector
connecteur

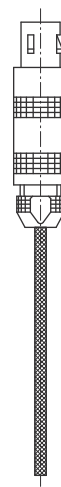

Bestell-Nr.
Order-N°.
N° de commande

396462

Ergänzungsartikel Optional extras Options

T81

Bestell-Nr.
Order-N°.
N° de commande

Ausgleichsleitung	Fe-CuNi (J),	Silicon / Keramik / Glasseide / Edelstahl	396517
Compensating cable	Fe-CuNi (J),	silicon / ceramic / glas silk / stainless steel	
Câble de compensation	Fe-CuNi (J),	silicone / céramique / soie de verre / acier inox	
Ausgleichsleitung	Fe-CuNi (L),	Silicon / Keramik / Glasseide / Edelstahl	396518
Compensating cable	Fe-CuNi (L),	silicon / ceramic / glas silk / stainless steel	
Câble de compensation	Fe-CuNi (L),	silicone / céramique / soie de verre / acier inox	
Ausgleichsleitung	NiCr-Ni (K),	Silicon / Keramik / Glasseide / Edelstahl	396519
Compensating cable	NiCr-Ni (K),	silicon / ceramic / glas silk / stainless steel	
Câble de compensation	NiCr-Ni (K),	silicone / céramique / soie de verre / acier inox	

Stand: 6. 03. 2019

Ergänzungsartikel Optional extras Options	Bestell-Nr. Order-N°. N° de commande	
	T21/T22	T41/T46
Einbaulänge vom Standard abweichend Useful length divergent to standard Longueur utile divergent de le standard	396011	396011
Halsrohr 30 mm lang Neck extension, length 30 mm Tube extension, longueur 30 mm	395731	-
Halsrohr 60 mm lang Neck extension, length 60 mm Tube extension, longueur 60 mm	395732	-
Halsrohr 90 mm lang Neck extension, length 90 mm Tube extension, longueur 90 mm	395733	-
Halsrohr 250 mm lang Neck extension, length 250 mm Tube extension, longueur 250 mm	395873	-
Halsrohrlänge vom Standard abweichend Neck extension length divergent to standard Longuer du tube extension divergent de le standard	396010	-
Schutzrohr auf 6mm abgesetzt, 60mm lang Thermowell at 6mm set down, length 60mm Doigt de grant déposer 6mm, longueur 60mm	396115	-
Thermopaar nach DIN EN 60584 2x Fe-CuNi Typ (J) Thermocouple per DIN EN 60584 2x Fe-CuNi type (J) Thermocouple selon DIN EN 60584 2x Fe-CuNi type (J)	395880	-
Doppel-Thermopaar nach DIN EN 60584 2x Fe-CuNi Typ (J) Dual thermocouple per DIN EN 60584 2x Fe-CuNi type (J) Thermocouple double selon DIN EN 60584 2x Fe-CuNi type (J)	396021	396021
Doppel-Thermopaar nach DIN EN 60584 2x NiCr-Ni Typ (K) Dual thermocouple per DIN EN 60584 2x NiCr-Ni type (K) Thermocouple double selon DIN EN 60584 2x NiCr-Ni type (K)	395889	395889
Thermopaar nach DIN EN 60584 Pt13Rh-Pt Typ (R) Thermocouple per DIN EN 60584 Pt13Rh-Pt type (R) Thermocouple selon DIN EN 60584 Pt13Rh-Pt type (R)	395881	395881
Doppel-Thermopaar nach DIN EN 60584 2x Pt13Rh-Pt Typ (R) Dual thermocouple per DIN EN 60584 2x Pt13Rh-Pt type (R) Thermocouple double selon DIN EN 60584 2x Pt13Rh-Pt type (R)	396022	396022
Thermopaar nach DIN EN 60584 Pt10Rh-Pt Typ (S) Thermocouple per DIN EN 60584 Pt10Rh-Pt type (S) Thermocouple selon DIN EN 60584 Pt10Rh-Pt type (S)	396520	-
Doppel-Thermopaar nach DIN EN 60584 2x Pt10Rh-Pt Typ (S) Dual thermocouple per DIN EN 60584 2x Pt10Rh-Pt type (S) Thermocouple double selon DIN EN 60584 2x Pt10Rh-Pt type (S)	396521	-
Thermopaar nach DIN EN 60584 Pt30Rh-Pt6Rh Typ (B) Thermocouple per DIN EN 60584 Pt30Rh-Pt6Rh type (B) Thermocouple selon DIN EN 60584 Pt30Rh-Pt6Rh type (B)	396522	-
Doppel-Thermopaar nach DIN EN 60584 2x Pt30Rh-Pt6Rh Typ (B) Dual thermocouple per DIN EN 60584 2x Pt30Rh-Pt6Rh type (B) Thermocouple double selon DIN EN 60584 2x Pt30Rh-Pt6Rh type (B)	396523	-
Thermopaar nach DIN 43710 Fe-CuNi Typ (L) Thermocouple per DIN 43710 Fe-CuNi type (L) Thermocouple selon DIN 43710 Fe-CuNi type (L)	396524	-
Doppel-Thermopaar nach DIN 43710 2x Fe-CuNi Typ (L) Dual thermocouple per DIN 43710 2x Fe-CuNi type (L) Thermocouple double selon DIN 43710 2x Fe-CuNi type (L)	396525	-

Ergänzungsartikel Optional extras Options	Bestell-Nr. Order-N°. N° de commande			
	T53	T61	T63.5/6	T81
Nennlänge vom Standard abweichend Length divergent to standard Longueur divergent de le standard	396242	396242	-	-
Ausgleichsleitung Fe-CuNi (J), Silicon / Keramik / Glasseide / Edelstahl Compensating cable Fe-CuNi (J), silicon / ceramic / glas silk / stainless steel Câble de compensation Fe-CuNi (J), silicone / céramique / soie de verre / acier inox	396517	-	-	396517
Ausgleichsleitung Fe-CuNi (L), Silicon / Keramik / Glasseide / Edelstahl Compensating cable Fe-CuNi (L), silicon / ceramic / glas silk / stainless steel Câble de compensation Fe-CuNi (L), silicone / céramique / soie de verre / acier inox	396518	396518	-	396518
Ausgleichsleitung NiCr-Ni (K), Silicon / Keramik / Glasseide / Edelstahl Compensating cable NiCr-Ni (K), silicon / ceramic / glas silk / stainless steel Câble de compensation NiCr-Ni (K), silicone / céramique / soie de verre / acier inox	396519	396519	396519	396519

Stand: 28.03.2019