

# Druckmessgerät mit Rohrfedersystem, Cu/Sn8

## Bourdon tube pressure gauge, brass

### Manomètres à tube de Bourdon, laiton

# R11



- Anwendung**  
 Für gasförmige und flüssige, nicht hochviskose und nicht kristallisierende Messstoffe.  
 An Messstellen mit Vibrationen und hohen dynamischen Druckbelastungen besonders geeignet.
- Service intended**  
 Suitable for all gaseous and liquid media that will not obstruct the pressure system.  
 Specifically appropriate for measuring points exposed to vibration and high dynamic load.
- Utilisation**  
 Pour fluides gazeux et liquides, non visqueux et non cristallisants.  
 Adapté particulièrement aux points de mesure avec vibrations et charge de pression dynamique élevée.

Technische Daten	Technical Data	Caractéristiques techniques
<b>Ausführung</b> EN 837-1 - Code S1	<b>Construction</b> EN 837-1 - Code S1	<b>Version</b> EN 837-1 - Code S1
<b>Gehäuse</b> Ø 60, 100, 160 und 250 mm, Edelstahl mit Glycerinfüllung, Ausblasvorrichtung und Innendruckausgleich	<b>Case</b> Ø 60, 100, 160 and 250 mm, stainless steel with glycerin-filling, pressure relief and internal pressure compensation	<b>Boîtier</b> Ø 60, 100, 160 et 250 mm, acier inox avec remplissage de glycérine, évent de sécurité et compensation de pression intérieure
<b>Schutzart</b> IP 65 nach EN 60529 / IEC 529	<b>Degree of protection</b> IP 65 per EN 60529 / IEC 529	<b>Degré de protection</b> IP 65 selon EN 60529 / IEC 529
<b>Anschluss</b> Ø 60mm : G1/4B, Messing Ø 100, 160, 250 mm : G1/2B, Messing	<b>Pressure connection</b> Ø 60 mm : G1/4B, brass Ø 100, 160, 250 mm : G1/2B, brass	<b>Raccord</b> Ø 60 mm : G1/4B, laiton Ø 100, 160 et 250 mm : G1/2B, laiton
<b>Messorgan</b> < 100 bar, CuSn8 - 2.1030, weichgelötet > 100 bar, Edelstahl - 1.4404, hartgelötet	<b>Pressure element</b> <100 bar, CuSn8 - 2.1030, soft-soldered >100 bar, stainless steel - 316L, hard-soldered	<b>Organe moteur</b> < 100 bar, CuSn8 - 2.1030, soudure à l' étain > 100 bar, acier inox - Z3 CND 17-11-02, brasure
<b>Zeigerwerk</b> Grund- und Deckplatte aus Messing Laufteile aus Neusilber	<b>Movement</b> Base and cover plate, brass Drive shaft, nickel silver	<b>Mouvement</b> Platine, laiton Axiale, argentan
<b>Zeiger</b> Aluminium, schwarz	<b>Pointer</b> Aluminium, black	<b>Aiguille</b> Duralumin, noir
<b>Zifferblatt</b> Aluminium, weiß Skala und Beschriftung schwarz	<b>Dial</b> Aluminium, white Scale and lettering black	<b>Cadran</b> Duralumin, blanc Échelle et graduation en noir
<b>Sichtscheibe</b> Ø 60 mm - Polycarbonat Ø 100, 160, 250 mm - Mehrschicht-Sicherheitsglas	<b>Window</b> Ø 60 mm - Polycarbonat Ø 100, 160, 250 mm - Laminated safety glas	<b>Voyant</b> Ø 60 mm - Polycarbonat Ø 100, 160, 250 mm - Verre de sécurité feuilleté
<b>Genauigkeitsklasse</b> Ø 60 mm : 1,6 Ø 100, 160 und 250 mm : 1,0	<b>Accuracy class</b> Ø 60 mm : 1,6 Ø 100, 160 und 250 mm : 1,0	<b>Précision</b> Ø 60 mm : 1,6 Ø 100, 160 et 250 mm : 1,0
<b>Temperatureinfluss, T<sub>Ref</sub> 20°C</b> Temperaturzunahme : +0,3% FS / 10K Temperaturabnahme : - 0,3% FS / 10K	<b>Temperature error, T<sub>ref</sub> 20°C</b> Rising temperature : +0,3% FS / 10 K Falling temperature : -0,3% FS / 10 K	<b>Influence de la température T<sub>ref</sub> 20°C</b> Hausse des températures: +0,3% de l'EM/10 K Baisse des températures : -0,3% de l'EM/10 K
<b>Umgebungstemperatur</b> T <sub>min</sub> / T <sub>max</sub> - 25°C ... + 60°C	<b>Ambient temperature</b> T <sub>min</sub> / T <sub>max</sub> - 25°C ... + 60°C	<b>Température ambiante</b> T <sub>mini</sub> / T <sub>maxi</sub> - 25°C ... + 60°C
<b>Messstofftemperatur</b> T <sub>max</sub> bei weichgelötetem Messorgan + 60°C bei hartgelötetem Messorgan +100°C	<b>Medium temperature</b> T <sub>max</sub> Soft soldered pressure element + 60°C Brazed pressure element +100°C	<b>Température du fluide</b> T <sub>maxi</sub> Organe moteur soudé + 60°C Organe moteur brasé +100°C
<b>Belastung</b> ruhende Last : 1,0 x Skalenendwert dynamische Last : 0,9 x Skalenendwert kurzfristige Überlast : 1,3 x Skalenendwert	<b>Working pressure</b> Steady : 1,0 x full scale value Fluctuating : 0,9 x full scale value Short time : 1,3 x full scale value	<b>Plages d'utilisation</b> Charge statique : 100% de fin d'échelle Charge dynamique : 90% de fin d'échelle Momentanément : 130% de fin d'échelle
<b>Ergänzungen</b> siehe Tabellen Seiten 01.0305 - 01.0306	<b>Optional extras</b> see tables pages 01.0305 - 01.0306	<b>Options</b> voir tableaux pages 01.0305 - 01.0306
<b>Druckmittler</b> siehe Seiten 06.0000 - 06.1502	<b>Chemical seals</b> siehe Seiten 06.0000 - 06.1502	<b>Séparateurs à membrane</b> siehe Seiten 06.0000 - 06.1502
<b>Grenzsignalgeber</b> siehe Seiten 01.1001 - 01.1002	<b>Alarm contacts</b> see pages 01.1001 - 01.1002	<b>Seuils d'alarme électriques</b> voir pages 01.1001 - 01.1002

# R11

## Druckmessgerät mit Rohrfedersystem, Cu/Sn8 Bourdon tube pressure gauge, brass Manomètres à tube de Bourdon, laiton

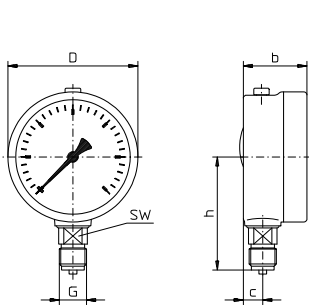

**Typ R11.U.1.N...**  
Anschluss unten  
bottom pressure entry  
raccord en bas

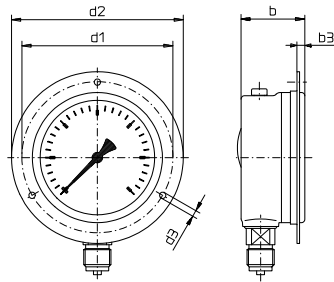

**Typ R11.U.2.N...**  
Rand vorne  
panel mounting flange  
collerette avant

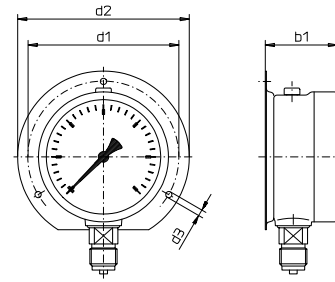

**Typ R11.U.3.N...**  
Rand hinten  
surface mounting flange  
rebord arrière

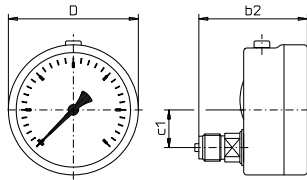

**Typ R11.H.1.N...**  
Anschluss hinten  
back pressure entry  
raccord arrière

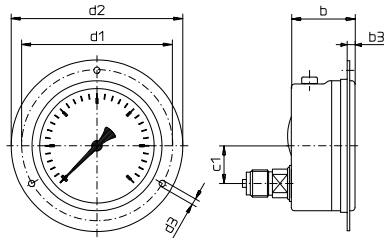

**Typ R11.H.2.N...**  
Rand vorne  
panel mounting flange  
collerette avant

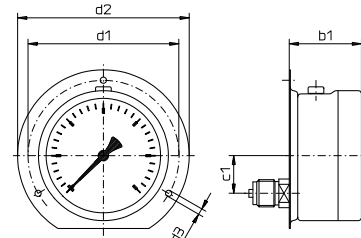

**Typ R11.H.3.N...**  
Rand hinten  
surface mounting flange  
rebord arrière

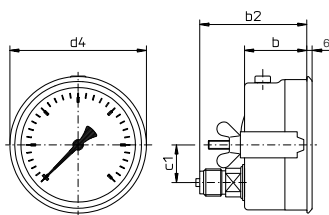

**Typ R11.H.4.N... \*)**  
Dreikantfrontring  
triangular bezel  
collerette avant triangulaire

NG	b	b1	b2	b3	c	c1	D	d1	d2	d3	d4	G	h	SW	Tafelausschnitt panel cut-out découpe du panneau		kg
	mm																
60 <sup>1)</sup>	28,5	32,5	54	6	11	0	63	75	85	3,5	67	G <sup>1</sup> / <sub>4</sub> B	54	14	65	*) 63	0,2
100	50	56	86,5		15	29	100	116	132	4,8	107	G <sup>1</sup> / <sub>2</sub> B	87	22	105	*) 103	0,85
160	50	56	88		14,5	50	160	178	196	5,8	166		118	22	165	*) 163	1,9
250	55	61	93		16	50	250	271	285	5,8	-		165	254	-	2,20	

<sup>1)</sup> Anschluss hinten zentrisch.  
pressure entry back, centrally  
raccord arrière central

**Druckmessgerät mit Rohrfedersystem, Cu/Sn8**  
**Bourdon tube pressure gauge, brass**  
**Manomètres à tube de Bourdon, laiton**

**R11**

Typ	R11.U.1.N60	R11.U.2.N60	R11.U.3.N60	R11.H.1.N60	R11.H.2.N60	R11.H.3.N60	R11.H.4.N60
<b>Ø 60mm</b>							
Anzeigebereich, bar Scale range, bar Etendues de mesure, bar	Bestell-Nr. Order-N° N° de commande						
- 1 ... 0	109566	101570	100030	109857	109883	101593	109933
- 0,6 ... 0 ... + 1,0	109567	101571	100031	109858	109884	101594	109934
- 1 ... 0 ... + 0,6	109568	101572	100032	109859	109885	101595	109935
- 1 ... 0 ... + 1,5	109569	101573	100033	109860	109886	101596	109936
- 1 ... 0 ... + 3	109570	101574	100034	109861	109887	101597	109937
- 1 ... 0 ... + 5	109571	101575	100035	109862	109888	101598	109938
- 1 ... 0 ... + 9	109572	101576	100036	109863	109889	101599	109939
- 1 ... 0 ... + 15	109838	101577	100037	109864	109890	101600	109940
- 1 ... 0 ... + 24	109839	101616	109856	110894	110895	101618	110896
0 ... 1,0	109841	101578	100040	109867	109893	101601	109943
0 ... 1,6	109842	101579	100041	109868	109894	101602	109944
0 ... 2,5	109843	101580	100042	109869	109895	101603	109945
0 ... 4	109844	101581	100043	109870	109896	101604	109946
0 ... 6	109845	101582	100044	109871	109897	101605	109947
0 ... 10	109846	101583	100045	109872	109898	101606	109948
0 ... 16	109847	101584	100046	109873	109899	101607	109949
0 ... 25	109848	101585	100047	109874	109900	101608	109950
0 ... 40	109849	101586	100048	109875	109901	101609	109951
0 ... 60	109850	101587	100049	109876	109902	101610	109952
0 ... 100	109851	101588	100050	109877	109903	101611	109953
0 ... 160	109852	101589	100051	109878	109928	101612	109954
0 ... 250	109853	101590	100052	109879	109929	101613	109955
0 ... 400	109854	101591	100053	109880	109930	101614	109956
0 ... 600	109855	101592	100054	109881	109931	101615	109957
0 ... 1000	109565	101617	100055	109866	109892	101619	109942

Typ	R11.U.1.N100	R11.U.2.N100	R11.U.3.N100	R11.H.1.N100	R11.H.2.N100	R11.H.3.N100	R11.H.4.N100
<b>Ø 100mm</b>							
Anzeigebereich, bar Scale range, bar Etendues de mesure, bar	Bestell-Nr. Order-N° N° de commande						
- 1,2 ... 0	113505	113533	113561	113589	113617	113645	113673
- 1 ... 0	113506	113534	113562	113590	113618	113646	113674
- 0,6 ... 0 ... + 1,0	113507	113535	113563	113591	113619	113647	113675
- 1 ... 0 ... + 0,6	113508	113536	113564	113592	113620	113648	113676
- 1 ... 0 ... + 1,5	113509	113537	113565	113593	113621	113649	113677
- 1 ... 0 ... + 3	113510	113538	113566	113594	113622	113650	113678
- 1 ... 0 ... + 5	113511	113539	113567	113595	113623	113651	113679
- 1 ... 0 ... + 9	113512	113540	113568	113596	113624	113652	113680
- 1 ... 0 ... + 15	113513	113541	113569	113597	113625	113653	113681
- 1 ... 0 ... + 24	113532	113542	113588	113616	113644	113672	113700
0,2 ... 1,0	113514	113560	113570	113598	113626	113654	113682
0 ... 0,6	113515	113543	113571	113599	113627	113655	113683
0 ... 1,0	113516	113544	113572	113600	113628	113656	113684
0 ... 1,6	113517	113545	113573	113601	113629	113657	113685
0 ... 2,5	113518	113546	113574	113602	113630	113658	113686
0 ... 4	113519	113547	113575	113603	113631	113659	113687
0 ... 6	113520	113548	113576	113604	113632	113660	113688
0 ... 10	113521	113549	113577	113605	113633	113661	113689
0 ... 16	113522	113550	113578	113606	113634	113662	113690
0 ... 25	113523	113551	113579	113607	113635	113663	113691
0 ... 40	113524	113552	113580	113608	113636	113664	113692
0 ... 60	113525	113553	113581	113609	113637	113665	113693
0 ... 100	113526	113554	113582	113610	113638	113666	113694
0 ... 160	113527	113555	113583	113611	113639	113667	113695
0 ... 250	113528	113556	113584	113612	113640	113668	113696
0 ... 400	113529	113557	113585	113613	113641	113669	113697
0 ... 600	113530	113558	113586	113614	113642	113670	113698
0 ... 1000	113531	113559	113587	113615	113643	113671	113699







Stand: 1. 07. 2026







**R11**

# Druckmessgerät mit Rohrfedersystem, Cu/Sn8

## Bourdon tube pressure gauge, brass

### Manomètres à tube de Bourdon, laiton



Typ	R11.U.1.N160	R11.U.2.N160	R11.U.3.N160	R11.H.1.N160	R11.H.2.N160	R11.H.3.N160	R11.H.4.N160
<b>Ø 160mm</b>							
Anzeigebereich, bar Scale range, bar Echelles de mesure, bar	Bestell-Nr. Order-N°. N° de commande						
- 1,2 ... 0	113701	113729	113757	113785	113813	113841	113869
- 1 ... 0	113702	113730	113758	113786	113814	113842	113870
- 0,6 ... 0 ... + 1,0	113703	113731	113759	113787	113815	113843	113871
- 1 ... 0 ... + 0,6	113704	113732	113760	113788	113816	113844	113872
- 1 ... 0 ... + 1,5	113705	113733	113761	113789	113817	113845	113873
- 1 ... 0 ... + 3	113706	113734	113762	113790	113818	113846	113874
- 1 ... 0 ... + 5	113707	113735	113763	113791	113819	113847	113875
- 1 ... 0 ... + 9	113708	113736	113764	113792	113820	113848	113876
- 1 ... 0 ... + 15	113709	113737	113765	113793	113821	113849	113877
- 1 ... 0 ... + 24	113728	113756	113784	113812	113840	113868	113896
0,2 ... 1,0	113710	113738	113766	113794	113822	113850	113878
0 ... 0,6	113711	113739	113767	113795	113823	113851	113879
0 ... 1,0	113712	113740	113768	113796	113824	113852	113880
0 ... 1,6	113713	113741	113769	113797	113825	113853	113881
0 ... 2,5	113714	113742	113770	113798	113826	113854	113882
0 ... 4	113715	113743	113771	113799	113827	113855	113883
0 ... 6	113716	113744	113772	113800	113828	113856	113884
0 ... 10	113717	113745	113773	113801	113829	113857	113885
0 ... 16	113718	113746	113774	113802	113830	113858	113886
0 ... 25	113719	113747	113775	113803	113831	113859	113887
0 ... 40	113720	113748	113776	113804	113832	113860	113888
0 ... 60	113721	113749	113777	113805	113833	113861	113889
0 ... 100	113722	113750	113778	113806	113834	113862	113890
0 ... 160	113723	113751	113779	113807	113835	113863	113891
0 ... 250	113724	113752	113780	113808	113836	113864	113892
0 ... 400	113725	113753	113781	113809	113837	113865	113893
0 ... 600	113726	113754	113782	113810	113838	113866	113894
0 ... 1000	113727	113755	113783	113811	113839	113867	113895

Typ	R11.U.1.N250	R11.U.2.N250	R11.U.3.N250	R11.H.1.N250	R11.H.2.N250	R11.H.3.N250
<b>Ø 250mm</b>						
Anzeigebereich, bar Scale range, bar Echelles de mesure, bar	Bestell-Nr. Order-N°. N° de commande					
- 1,2 ... 0	113897	113925	113953	113981	114009	114037
- 1 ... 0	113898	113926	113954	113982	114010	114038
- 0,6 ... 0 ... + 1,0	113899	113927	113955	113983	114011	114039
- 1 ... 0 ... + 0,6	113900	113928	113956	113984	114012	114040
- 1 ... 0 ... + 1,5	113901	113929	113957	113985	114013	114041
- 1 ... 0 ... + 3	113902	113930	113958	113986	114014	114042
- 1 ... 0 ... + 5	113903	113931	113959	113987	114015	114043
- 1 ... 0 ... + 9	113904	113932	113960	113988	114016	114044
- 1 ... 0 ... + 15	113905	113933	113961	113989	114017	114045
- 1 ... 0 ... + 24	113924	113952	113980	114008	114036	114064
0,2 ... 1	113906	113934	113962	113990	114018	114046
0 ... 0,6	113907	113935	113963	113991	114019	114047
0 ... 1	113908	113936	113964	113992	114020	114048
0 ... 1,6	113909	113937	113965	113993	114021	114049
0 ... 2,5	113910	113938	113966	113994	114022	114050
0 ... 4	113911	113939	113967	113995	114023	114051
0 ... 6	113912	113940	113968	113996	114024	114052
0 ... 10	113913	113941	113969	113997	114025	114053
0 ... 16	113914	113942	113970	113998	114026	114054
0 ... 25	113915	113943	113971	113999	114027	114055
0 ... 40	113916	113944	113972	114000	114028	114056
0 ... 60	113917	113945	113973	114001	114029	114057
0 ... 100	113918	113946	113974	114002	114030	114058
0 ... 160	113919	113947	113975	114003	114031	114059
0 ... 250	113920	113948	113976	114004	114032	114060
0 ... 400	113921	113949	113977	114005	114033	114061
0 ... 600	113922	113950	113978	114006	114034	114062
0 ... 1000	113923	113951	113979	114007	114035	114063

Ergänzungsartikel Optional extras Options	Ø 60	Ø 100	Ø 160	Ø 250
	Bestell-Nr. Order-N°. N° de commande			
Schutzkappe aus Gummi, blau Blue rubber cover Capuchon de protection en caoutchouc bleu	390067	395002	-	-
Gehäuse und Ring schwarz lackiert Case and bezel black finish Boîtier et baïonnette en acier peint en noir	-	395003	395036	395054
Frontring schwarz lackiert Bezel black finish Lunette peinte en noir	-	395004	395037	395055
Skala mit Feinteilung und Schneidenseiger Scale with fine spacing and knife edge pointer Échelle graduation fine et aiguille chantournée	395595	395019	395044	395057
Doppelskala, z.B. bar/psi Dual scale, for example bar/psi Échelle double, par exemple bar/psi	395071	395020	395045	395058
Mehrfachskala Multi scale Échelle multiple	395671	395671	395671	395671
Skalenaufschrift Lettering Inscriptions	395740	395740	395740	395740
Kältemittelskala Druck / R407c, R134a, R404a Refrigerant scale pressure/ R407c, R134a, R404a Échelles frigorigènes pression/ R407c, R134a, R404a	-	395565	395566	395567
Kältemittelskala Druck / R22, R12, R502 Refrigerant scale pressure/ R22, R12, R502 Échelles frigorigènes pression/ R22, R12, R502	-	395568	395569	395570
Kältemittelskala Druck / R134a Refrigerant scale pressure/ R134a Échelles frigorigènes pression/ R134a	-	395571	395572	395573
Kältemittelskala Druck / R407c Refrigerant scale pressure/ R407c Échelles frigorigènes pression/ R407c	-	395574	395575	395576
Kältemittelskala Druck / R507 Refrigerant scale pressure/ R507 Échelles frigorigènes pression/ R507	-	395577	395578	395579
Klischee-Erstellung für Sonderskala Block making for special scale Confection de clichés pour échelles spéciales	395022	395023	395047	395060
Mehrpreis je weitere Farbe auf dem Zifferblatt Extra charge per additional colour on dial Supplément de prix par couleur en plus sur le cadran	395025	395025	395025	395025
Messsystem aus Monel Monel pressure element Organe moteur en Monel	-	395008	395041	395796
Messsystem gereinigt für Sauerstoff Degreased pressure element for oxygen Organe moteur dégraissé pour oxygène	395069	395009	395042	395042
Messsystem silikonfrei Silicon free pressure element Organe moteur exempt de silicone	395698	395698	395699	395699
Messsystem überdrucksicher, mehr 1,3-fach Pressure element overpressure safe > 1,3 time Organe moteur résistant à plus de 1,3 fois de P	395594	395010	395043	395043
Drosselschraube im Anschlusszapfen 0,8mm Ø Restrictor screw in connector 0,8 mm dia. Vis frein de 0,8 mm dans le raccord	395070	395011	395011	395011
Drosselschraube im Anschlusszapfen 0,3mm Ø Restrictor screw in connector 0,3 mm dia. Vis frein de 0,3 mm dans le raccord	-	395583	395583	395583
Anschlusszapfen G 1/4 B Connector G 1/4 B Raccord G 1/4 B	-	395012	395012	-

Stand: 1. 07. 2026

Ergänzungsartikel Optional extras Options	Ø 60	Ø 100	Ø 160	Ø 250
	Bestell-Nr. Order-N° N° de commande			
Anschlusszapfen G 1/4 innen Connector G 1/4 female Raccord G 1/4 intérieur	-	395647	395647	395647
Anschlusszapfen G 3/8 B Connector G 3/8 B Raccord G 3/8 B	-	395013	395013	395013
Anschlusszapfen M 20 x 1,5 Connector M 20 x 1,5 Raccord M 20 x 1,5	-	395014	395014	395014
Anschlusszapfen 1/4-NPT Connector 1/4-NPT Raccord 1/4-NPT	-	395015	395015	-
Anschlusszapfen 3/8-NPT Connector 3/8-NPT Raccord 3/8-NPT	-	395016	395016	395016
Anschlusszapfen 1/2-NPT Connector 1/2-NPT Raccord 1/2-NPT	-	395017	395017	395017
Anschlusszapfen 7/16-20UNF-2A / SAE J513 Connector 7/16-20UNF-2A / SAE J513 Raccord 7/16-20UNF-2A / SAE J513	395018	395018	395018	-
Kleinflansch DIN28403 ISO2861 DN 10, Edelstahl Miniature flange DIN28403 ISO2861 DN 10, stainless steel Bride miniature DIN28403 ISO2861 DN 10, acier inox	-	395592	395592	395592
rote Marke auf dem Zifferblatt Red mark on dial Trait rouge sur le cadran	395074	395026	395026	395026
roter Markenzeiger in der Scheibe Red mark pointer in window Aiguille rouge sur le voyant	395075	395027	395048	395061
1-fach Schleppzeiger, rückstellbar One-way reset maximum pointer Aiguille suiveuse simple avec remise à zéro	395077	395029	395050	395063
2-fach Schleppzeiger, rückstellbar Two-way reset maximum pointer Aiguille suiveuse double avec remise à zéro	-	395030	395051	395064
Zeiger mit Zahntriebverstellung Adjustable pointer on bushing Aiguille micrométrique	396095	395031	395052	396096
DAkKS - kalibrierfähig DAkKS - calibrateable DAkKS - étalonnable	395032	395032	395032	395032
Schweißpunktsicherung für Bajonettring Spotweld protection for bayonet ring Assurance de la baïonnette par point de soudure	395763	395763	395763	395763
Zündschutzart Intrinsic safety Sécurité intrinsèque	104101	104101	104101	104101
 II 2G Ex h IIC T6...T1 Gb X II 2D Ex h IIC T6...T1 Db X				

 Druckmittler Chemical seals Séparateurs	06.0101 - 06.1502
 Grenzsinalgeber Alarm contacts Seuils d'alarme électriques	01.1001 - 01.1002