

# Druckmessgerät mit Rohrfedersystem, CuSn8

## Bourdon tube pressure gauges, brass

### Manomètres à tube de Bourdon, laiton

# R10

- **Anwendung**  
Für gasförmige und flüssige, nicht hochviskose und nicht kristallisierende Messstoffe.
- **Service intended**  
Suitable for all gaseous and liquid media that will not obstruct the pressure system.
- **Utilisation**  
Pour fluides gazeux et liquides, non visqueux et non cristallisants.



Technische Daten	Technical Data	Caractéristiques techniques
<b>Ausführung</b> EN 837-1	<b>Construction</b> EN 837-1	<b>Version</b> EN 837-1
<b>Gehäuse</b> Ø 100, 160 und 250 mm, Edelstahl Schalttafelenbaugehäuse DIN 43700 96x96, 144x144, 144x72 und 192x96 mm Kunststoff, schwarz	<b>Case</b> Ø 100, 160 and 250 mm, stainless steel Panel mounting case DIN 43700 96x96, 144x144, 144x72 und 192x96 mm Plastic, black	<b>Boîtier</b> Ø 100, 160 et 250 mm, acier inox Boîtier pour montage encastré DIN 43700 96x96, 144x144, 144x72 et 192x96 mm Plastique, noir
<b>Schutzart</b> IP 54 nach EN 60529 / IEC 529	<b>Protection class</b> IP 54 per EN 60529 / IEC 529	<b>Degré de protection</b> IP 54 selon EN 60529 / IEC 529
<b>Anschluss</b> G1/2B, Messing	<b>Pressure connection</b> G1/2B, brass	<b>Raccord pression</b> G1/2B, laiton
<b>Messorgan</b> < 100 bar, CuSn8 - 2.1030, weichgelötet > 100 bar, Edelstahl - 1.4404, hartgelötet	<b>Pressure element</b> <100 bar, CuSn8 - 2.1030, soft-soldered >100 bar, st.st. - 316L, hard-soldered	<b>Organe moteur</b> < 100 bar, CuSn8 - 2.1030, soudure à l' étain > 100 bar, acier inox - Z3 CND 17-11-02, brasure
<b>Zeigerwerk</b> Grund- und Deckplatte aus Messing Laufteile aus Neusilber	<b>Movement</b> Base and cover plate, brass Drive shaft, nickel silver	<b>Mouvement</b> Platine, laiton Axiale, argentan
<b>Zeiger</b> Aluminium bzw. Kunststoff, schwarz	<b>Pointer</b> Aluminium or plastic, black	<b>Aiguille</b> Duralumin ou matière plastique, noir
<b>Zifferblatt</b> Aluminium, weiß Skala und Beschriftung schwarz	<b>Dial</b> Aluminium white Scale and lettering black	<b>Cadran</b> Duralumin, blanc Échelle et graduation en noir
<b>Sichtscheibe</b> Instrumentenglas	<b>Window</b> Instrument glass	<b>Voyant</b> Verre d'instrumentation
<b>Genauigkeitsklasse</b> 1,0	<b>Accuracy class</b> 1,0	<b>Précision</b> 1,0
<b>Temperatureinfluss, T<sub>Ref</sub> 20°C</b> Temperaturzunahme : +0,3% FS / 10K Temperaturabnahme : - 0,3% FS / 10K	<b>Temperature error, T<sub>ref</sub> 20°C</b> Rising temperature : +0,3% of FS value / 10 K Falling temperature : -0,3% of FS value / 10 K	<b>Influence de la température T<sub>ref</sub> 20°C</b> Hausse des températures: +0,3% de l'EM/10 K Baisse des températures : -0,3% de l'EM/10 K
<b>Umgebungstemperatur</b> T <sub>min</sub> / T <sub>max</sub> - 40°C ... + 60°C	<b>Ambient temperature</b> T <sub>min</sub> / T <sub>max</sub> - 40°C ... + 60°C	<b>Température ambiante</b> T <sub>mini</sub> / T <sub>maxi</sub> - 40°C ... + 60°C
<b>Messstofftemperatur</b> T <sub>max</sub> bei weichgelötetem Messorgan + 80°C bei hartgelötetem Messorgan +120°C	<b>Medium temperature</b> T <sub>max</sub> Soft soldered pressure element + 80°C Brazed pressure element +120°C	<b>Température du fluide</b> T <sub>maxi</sub> Organe moteur soudé + 80°C Organe moteur brasé +120°C
<b>Belastung</b> ruhende Last : 1,0 x Skalenendwert dynamische Last : 0,9 x Skalenendwert kurzfristige Überlast : 1,3 x Skalenendwert	<b>Working pressure</b> Steady : 1,0 x full scale value Fluctuating : 0,9 x full scale value Short time : 1,3 x full scale value	<b>Plages d'utilisation</b> Charge statique : 100% de fin d'échelle Charge dynamique : 90% de fin d'échelle Momentanément : 130% de fin d'échelle
<b>Ergänzungen</b> siehe Tabellen Seiten 01.0205 - 01.0206	<b>Optional extras</b> see tables pages 01.0205 to 01.0206	<b>Options</b> voir tableaux pages 01.0205 - 01.0206
<b>Grenzsignalgeber</b> siehe Seiten 01.1101 - 01.1102	<b>Alarm contacts</b> see pages 01.1101 - 01.1102	<b>Seuils d'alarme électriques</b> voir pages 01.1101 - 01.1102
<b>Ferngeber</b> siehe Seiten 01.1201 - 01.1203	<b>Transmitters</b> see pages 01.1201 - 01.1203	<b>Transmetteurs</b> voir pages 01.1201 - 01.1203
<b>Druckmittler</b> siehe Seiten 06.0000 - 06.1502	<b>Chemical seals</b> see pages 06.0000 - 06.1502	<b>Séparateurs à membrane</b> voir pages 06.0000 - 06.1502

# R10

## Druckmessgerät mit Rohrfedersystem, CuSn8 Bourdon tube pressure gauges, brass Manomètres à tube de Bourdon, laiton

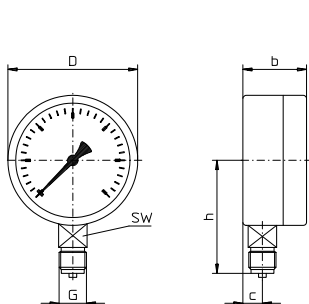

**Typ R10.U.1.N...**  
Anschluss unten  
bottom pressure entry  
raccord en bas

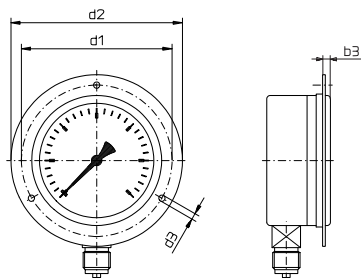

**Typ R10.U.2.N...**  
Rand vorne  
panel mounting flange  
collerette avant

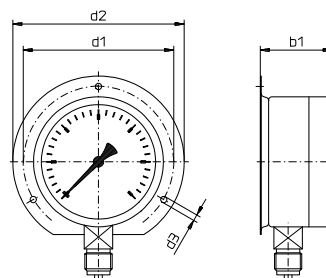

**Typ R10.U.3.N...**  
Rand hinten  
surface mounting flange  
rebord arrière

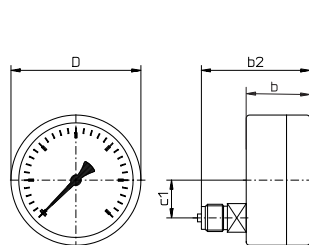

**Typ R10.H.1.N...**  
Anschluss hinten  
back pressure entry  
raccord arrière

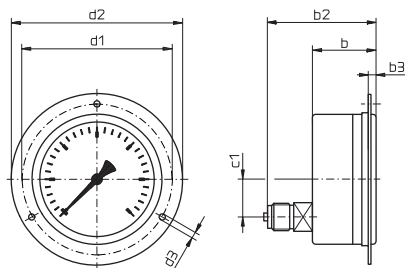

**Typ R10.H.2.N...**  
Rand vorne  
panel mounting flange  
collerette avant

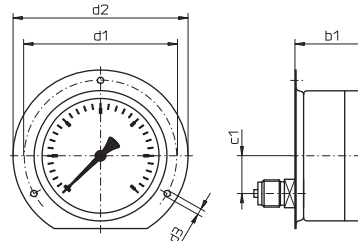

**Typ R10.H.3.N...**  
Rand hinten  
surface mounting flange  
rebord arrière

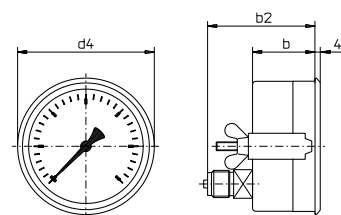

**Typ R10.H.4.N... \*)**  
Dreikantfrontring  
triangular bezel  
collerette avant triangulaire

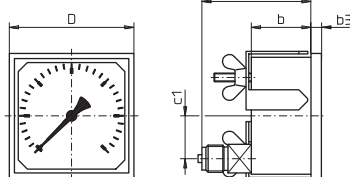

**Typ R10.H.2.N...**  
Quadratgehäuse DIN 43700  
square panel mounting  
boîtier carré

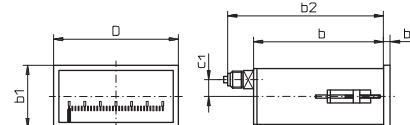















**Typ R10.H.2.N...**  
Profilgehäuse DIN 43700  
edgewise panel mounting  
boîtier de profil

NG	b	b1	b2	b3	c	c1	D	d1	d2	d3	d4	G	h	SW	Tafelausschnitt	kg			
															panel cut-out				
															découpe du panneau				
100	50	56	86,5	6	15	29	100	116	132	4,8	107	G½B	87	22	105	*) 103	0,5		
160	50	56	88		14,5	50	160	178	196	5,8	166		118		165	165	*) 163	1,1	
250	55	61	93		16	50	250	271	285	5,8	-		-		-	-	254	-	2,2
96 x 96	47	-	81	8	-	29	96	-	-	-	-	G½B	-	22	92 x 92	-	0,8		
144 x 144	47	-	81		-	50	144	-	-	-	-		-		-	-	138 x 138	-	1,1
144 x 72	139,5	72	175		-	7	144	-	-	-	-		-		-	-	138 x 68	-	1,3
192 x 96	139,5	96	175		-	7	192	-	-	-	-		-		-	-	186 x 92	-	2,4







**Druckmessgerät mit Rohrfedersystem, CuSn8**  
**Bourdon tube pressure gauges, brass**  
**Manomètres à tube de Bourdon, laiton**

**R10**

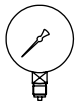
Typ	R10.U.1.N100	R10.U.2.N100	R10.U.3.N100	R10.H.1.N100	R10.H.2.N100	R10.H.3.N100	R10.H.4.N100
<b>Ø 100mm</b>							
Anzeigebereich, bar Scale range, bar Etuendues de mesure, bar	Bestell-Nr. Order-N° N° de commande						
- 1200 ... 0	100589	100617	100645	100673	100702	100730	100757
- 1 ... 0	100590	100618	100646	100674	100703	100731	100758
- 0,6 ... 0 ... + 1,0	100591	100619	100647	100675	100704	100732	100759
- 1 ... 0 ... + 0,6	100592	100620	100648	100676	100705	100733	100760
- 1 ... 0 ... + 1,5	100593	100621	100649	100677	100706	100734	100761
- 1 ... 0 ... + 3	100594	100622	100650	100678	100707	100735	100762
- 1 ... 0 ... + 5	100595	100623	100651	100679	100708	100736	100763
- 1 ... 0 ... + 9	100596	100624	100652	100680	100709	100737	100764
- 1 ... 0 ... + 15	100597	100625	100653	100681	100710	100738	100765
- 1 ... 0 ... + 24	100616	100644	100672	100701	100729	100688	100784
0,2 ... 1,0	100598	100626	100654	100682	100711	100739	100766
0 ... 0,6	100599	100627	100655	100683	100712	100740	100767
0 ... 1,0	100600	100628	100656	100684	100713	100741	100768
0 ... 1,6	100601	100629	100657	100685	100714	100742	100769
0 ... 2,5	100602	100630	100658	100686	100715	100743	100770
0 ... 4	100603	100631	100659	100687	100716	100744	100771
0 ... 6	100604	100632	100660	100689	100717	100745	100772
0 ... 10	100605	100633	100661	100690	100718	100746	100773
0 ... 16	100606	100634	100662	100691	100719	100747	100774
0 ... 25	100607	100635	100663	100692	100720	100748	100775
0 ... 40	100608	100636	100664	100693	100721	100749	100776
0 ... 60	100609	100637	100665	100694	100722	100750	100777
0 ... 100	100610	100638	100666	100695	100723	100751	100778
0 ... 160	100611	100639	100667	100696	100724	100752	100779
0 ... 250	100612	100640	100668	100697	100725	100753	100780
0 ... 400	100613	100641	100669	100698	100726	100754	100781
0 ... 600	100614	100642	100670	100699	100727	100755	100782
0 ... 1000	100615	100643	100671	100700	100728	100756	100783

Typ	R10.U.1.N160	R10.U.2.N160	R10.U.3.N160	R10.H.1.N160	R10.H.2.N160	R10.H.3.N160	R10.H.4.N160
<b>Ø 160mm</b>							
Anzeigebereich, bar Scale range, bar Etuendues de mesure, bar	Bestell-Nr. Order-N° N° de commande						
- 1200 ... 0	100785	100813	100841	100869	100897	100925	100953
- 1 ... 0	100786	100814	100842	100870	100898	100926	100954
- 0,6 ... 0 ... + 1,0	100787	100815	100843	100871	100899	100927	100955
- 1 ... 0 ... + 0,6	100788	100816	100844	100872	100900	100928	100956
- 1 ... 0 ... + 1,5	100789	100817	100845	100873	100901	100929	100957
- 1 ... 0 ... + 3	100790	100818	100846	100874	100902	100930	100958
- 1 ... 0 ... + 5	100791	100819	100847	100875	100903	100931	100959
- 1 ... 0 ... + 9	100792	100820	100848	100876	100904	100932	100960
- 1 ... 0 ... + 15	100793	100821	100849	100877	100905	100933	100961
- 1 ... 0 ... + 24	100812	100840	100868	100896	100924	100952	100980
0,2 ... 1,0	100794	100822	100850	100878	100906	100934	100962
0 ... 0,6	100795	100823	100851	100879	100907	100935	100963
0 ... 1,0	100796	100824	100852	100880	100908	100936	100964
0 ... 1,6	100797	100825	100853	100881	100909	100937	100965
0 ... 2,5	100798	100826	100854	100882	100910	100938	100966
0 ... 4	100799	100827	100855	100883	100911	100939	100967
0 ... 6	100800	100828	100856	100884	100912	100940	100968
0 ... 10	100801	100829	100857	100885	100913	100941	100969
0 ... 16	100802	100830	100858	100886	100914	100942	100970
0 ... 25	100803	100831	100859	100887	100915	100943	100971
0 ... 40	100804	100832	100860	100888	100916	100944	100972
0 ... 60	100805	100833	100861	100889	100917	100945	100973
0 ... 100	100806	100834	100862	100890	100918	100946	100974
0 ... 160	100807	100835	100863	100891	100919	100947	100975
0 ... 250	100808	100836	100864	100892	100920	100948	100976
0 ... 400	100809	100837	100865	100893	100921	100949	100977
0 ... 600	100810	100838	100866	100894	100922	100950	100978
0 ... 1000	100811	100839	100867	100895	100923	100951	100979

Stand: 14. 09. 2018

Typ	R10.U.1.N250	R10.U.2.N250	R10.U.3.N250	R10.H.1.N250	R10.H.2.N250	R10.H.3.N250
<b>Ø 250mm</b>						
Anzeigebereich, bar Scale range, bar Etendues de mesure, bar	Bestell-Nr. Order-N°. N° de commande					
- 1200 ... 0	100981	101009	101037	101065	101093	101121
- 1 ... 0	100982	101010	101038	101066	101094	101122
- 0,6 ... 0 ... + 1,0	100983	101011	101039	101067	101095	101123
- 1 ... 0 ... + 0,6	100984	101012	101040	101068	101096	101124
- 1 ... 0 ... + 1,5	100985	101013	101041	101069	101097	101125
- 1 ... 0 ... + 3	100986	101014	101042	101070	101098	101126
- 1 ... 0 ... + 5	100987	101015	101043	101071	101099	101127
- 1 ... 0 ... + 9	100988	101016	101044	101072	101100	101128
- 1 ... 0 ... + 15	100989	101017	101045	101073	101101	101129
- 1 ... 0 ... + 24	101008	101035	101064	101092	101120	101148
0,2 ... 1,0	101008	101018	101046	101074	101102	101130
0 ... 0,6	100991	101019	101047	101075	101103	101131
0 ... 1,0	100992	101020	101048	101076	101104	101132
0 ... 1,6	100993	101021	101049	101077	101105	101133
0 ... 2,5	100994	101022	101050	101078	101106	101134
0 ... 4	100995	101023	101051	101079	101107	101135
0 ... 6	100996	101024	101052	101080	101108	101136
0 ... 10	100997	101025	101053	101081	101109	101137
0 ... 16	100998	101026	101054	101082	101110	101138
0 ... 25	100999	101027	101055	101083	101111	101139
0 ... 40	101000	101028	101056	101084	101112	101140
0 ... 60	101001	101029	101057	101085	101113	101141
0 ... 100	101002	101030	101058	101086	101114	101142
0 ... 160	101003	101036	101059	101087	101115	101143
0 ... 250	101004	101031	101060	101088	101116	101144
0 ... 400	101005	101032	101061	101089	101117	101145
0 ... 600	101006	101033	101062	101090	101118	101146
0 ... 1000	101007	101034	101063	101091	101119	101147

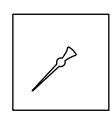
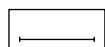
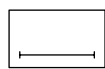
Typ	R10.H.2.96x96	R10.H.2.144x144	R10.H.2.144x72	R10.H.2.192x96
<b>96 x 96mm</b> <b>144 x 144mm</b> <b>144 x 72mm</b> <b>192 x 96mm</b>				
Anzeigebereich, bar Scale range, bar Etendues de mesure, bar	Bestell-Nr. Order-N°. N° de commande			
- 1200 ... 0	391273	391301	391329	391357
- 1 ... 0	391274	391302	391330	391358
- 0,6 ... 0 ... + 1,0	391275	391303	391331	391359
- 1 ... 0 ... + 0,6	391276	391304	391332	391360
- 1 ... 0 ... + 1,5	391277	391305	391333	391361
- 1 ... 0 ... + 3	391278	391306	391334	391362
- 1 ... 0 ... + 5	391279	391307	391335	391363
- 1 ... 0 ... + 9	391280	391308	391336	391364
- 1 ... 0 ... + 15	391281	391309	391337	391365
- 1 ... 0 ... + 24	391300	391328	391356	391384
0,2 ... 1,0	391282	391310	391338	391366
0 ... 0,6	391283	391311	391339	391367
0 ... 1,0	391284	391312	391340	391368
0 ... 1,6	391285	391313	391341	391369
0 ... 2,5	391286	391314	391342	391370
0 ... 4	391287	391315	391343	391371
0 ... 6	391288	391316	391344	391372
0 ... 10	391289	391317	391345	391373
0 ... 16	391290	391318	391346	391374
0 ... 25	391291	391319	391347	391375
0 ... 40	391292	391320	391348	391376
0 ... 60	391293	391321	391349	391377
0 ... 100	391294	391322	391350	391378
0 ... 160	391295	391323	391351	391379
0 ... 250	391296	391324	391352	391380
0 ... 400	391297	391325	391353	391381
0 ... 600	391298	391326	391354	391382
0 ... 1000	391299	391327	391355	391383



Druckmessgeräte mit Rohrfedersystem und Grenzsignalgebern  
Bourdon tube pressure gauge with alarm contacts  
Manomètres à tube de Bourdon avec seuil d'alarme

01.1101  
-  
01.1102



Druckmessgeräte mit Rohrfedersystem und Ferngeber  
Bourdon tube pressure gauge with transmitters  
Manomètres à tube de Bourdon avec transmetteurs

01.1201  
-  
01.1203



Druckmittler  
Chemical seals  
Séparateurs

06.0101  
-  
06.1502

Ergänzungsartikel Optional extras Options	Ø 100	Ø 160	Ø 250	96x96	144x144	144x72	192x96
	Bestell-Nr. Order-N°. N° de commande						
Schutzkappe aus Gummi, blau Blue rubber cover Capuchon de protection en caoutchouc bleu	395002	-	-	-	-	-	-
Gehäuse und Ring schwarz lackiert Case and bezel black finish Boîtier et baïonnette en acier peint en noir	395003	395036	395054	-	-	-	-
Frontring schwarz lackiert Bezel black finish Lunette peinte en noir	395004	395037	395055	-	-	-	-
Gehäuse tropensicher IP 65 nach EN 60529 / IEC 529 Case tropics-safe IP 65 per EN 60529 / IEC 529 Boîtier résistant aux tropiques IP 65 selon EN 60529 / IEC 529	395559	395559	395559	-	-	-	-
Zeigerwerk aus CrNi-Stahl Movement stainless steel Mouvement en acier inox	395005	395038	395038	395005	395038	395005	395038
Zeigerwerk achsgedämpft Movement with axle damping Axe du mouvement freiné	395563	395564	395564	395563	395564	-	-
Skala mit Feinteilung und Schneidenseiger Scale with fine spacing and knife edge pointer Échelle graduation fine et aiguille chantournée	395019	395044	395057	395019	395057	-	-
Doppelskala, z.B. bar/psi Dual scale, for example bar/psi Échelle double, par exemple bar/psi	395020	395045	395058	395020	395045	395020	395045
Mehrfachskala Multi scale Échelle multiple	395671	395671	395671	395671	395671	395671	395671
Skalenaufschrift, je Zeile Lettering, per line Inscriptions, par ligne	395740	395740	395740	395740	395740	395740	395740
Kältemittelskala Druck / R407c, R134a, R404a Refrigerant scale pressure/ R407c, R134a, R404a Échelles frigorigènes pression/ R407c, R134a, R404a	395565	395566	395567	-	-	-	-
Kältemittelskala Druck / R22, R12, R502 Refrigerant scale pressure/ R22, R12, R 502 Échelles frigorigènes pression/ R22, R12, R 502	395568	395569	395570	-	-	-	-
Kältemittelskala Druck / R134a Refrigerant scale pressure/ R134a Échelles frigorigènes pression/ R134a	395571	395572	395573	-	-	-	-
Kältemittelskala Druck / R407c Refrigerant scale pressure/ R407c Échelles frigorigènes pression/ R407c	395574	395575	395576	-	-	-	-
Kältemittelskala Druck / R507 Refrigerant scale pressure/ R507 Échelles frigorigènes pression/ R507	395577	395578	395579	-	-	-	-
Klischee-Erstellung für Sonderskala Block making for special scale Confection de clichés pour échelles spéciales	395023	395047	395060	395023	395047	395023	395047
Mehrpreis je weitere Farbe auf dem Zifferblatt Extra charge per additional colour on the dial Supplément de prix par couleur en plus sur cadran	395025	395025	395025	395025	395025	395025	395025
Mehrschichtensicherheitsglas Gehäuse Code S1 Laminated safety glass Case code S1 Verre de sécurité feuilleté Boîtier code S1	395006	395039	395056	-	-	-	-
Messsystem aus Monel Monel pressure element Organe moteur en Monel	395008	395041	395796	395008	395041	395008	395041
Messsystem gereinigt für Sauerstoff Degreased pressure element for oxygen Organe moteur dégraissé pour oxygène	395009	395042	395042	395009	395042	395009	395042
Messsystem silikonfrei Silicon free pressure element Organe moteur exempt de silicone	395698	395699	395699	395698	395699	395698	395699
Messsystem überdrucksicher, mehr 1,3-fach Pressure element overpressure safe > 1,3 time Organe moteur résistant à plus de 1,3 fois de P	395010	395043	395043	395010	395043	395010	395043
Drosselschraube im Anschlusszapfen 0,8mm Ø Restrictor screw in connector 0,8 mm dia. Vis frein de 0,8 mm dans le raccord	395011	395011	395011	395011	395011	395011	395011
Drosselschraube im Anschlusszapfen 0,3mm Ø Restrictor screw in connector 0,3 mm dia. Vis frein de 0,3 mm dans le raccord	395583	395583	395583	395583	395583	395583	395583

Ergänzungsartikel Optional extras Options	Ø 100	Ø 160	Ø 250	96x96	144x144	144x72	192x96
	Bestell-Nr. Order-N° N° de commande						
Anschlusszapfen G 1/4 B Connector G 1/4 B Raccord G 1/4 B	395012	395012	-	395012	395012	395012	395012
Anschlusszapfen G 1/4 innen Connector G 1/4 female Raccord G 1/4 intérieur	395647	395647	395647	395647	395647	395647	395647
Anschlusszapfen G 3/8 B Connector G 3/8 B Raccord G 3/8 B	395013	395013	395013	395013	395013	395013	395013
Anschlusszapfen M 20 x 1,5 Connector M 20 x 1,5 Raccord M 20 x 1,5	395014	395014	395014	395014	395014	395014	395014
Anschlusszapfen 1/4-NPT Connector 1/4-NPT Raccord 1/4-NPT	395015	395015	-	395015	395015	395015	395015
Anschlusszapfen 3/8-NPT Connector 3/8-NPT Raccord 3/8-NPT	395016	395016	395016	395016	395016	395016	395016
Anschlusszapfen 1/2-NPT Connector 1/2-NPT Raccord 1/2-NPT	395017	395017	395017	395017	395017	395017	395017
Anschlusszapfen 7/16-20UNF-2A / SAE J513 Connector 7/16-20UNF-2A / SAE J513 Raccord 7/16-20UNF-2A / SAE J513	395018	395018	-	395018	395018	395018	395018
Kleinflansch DIN28403 ISO 2861 DN 10, Edelstahl Miniature flange DIN 28403 ISO 2861 DN 10, st.st. Bride miniature DIN 28403 ISO 2861 DN 10, acier inox	395592	395592	395592	-	-	-	-
gelbe Marke auf dem Zifferblatt für Stickstoff Yellow mark on dial for nitrogen Marque jaune sur le cadran pour nitrogène	395910	395910	-	-	-	-	-
blaue Marke auf dem Zifferblatt für Sauerstoff Blue mark on dial for oxygen Marque bleue sur le cadran pour oxygène	395911	395911	-	-	-	-	-
rote Marke auf dem Zifferblatt Red mark on dial Traît rouge sur le cadran	395026	395026	395026	395026	395026	395026	395026
roter Markenzeiger in der Scheibe Red mark pointer in window Aiguille rouge sur le voyant	395027	395048	395061	395027	395048	-	-
roter Markenzeiger auf dem Zifferblatt Red mark pointer on dial Aiguille rouge sur le cadran	395028	395049	395062	395028	395049	-	-
roter Markenzeiger 2-fach auf dem Zifferblatt Red mark pointer two-way on dial Aiguille rouge double sur le cadran	396026	396026	-	-	-	-	-
1-fach Schleppzeiger, rückstellbar One-way reset maximum pointer Aiguille suiveuse simple avec remise à zéro	395029	395050	395063	395029	395050	-	-
2-fach Schleppzeiger, rückstellbar Two-way reset maximum pointer Aiguille suiveuse double avec remise à zéro	395030	395051	395064	395030	395051	-	-
Zeiger mit Zahntriebverstellung Adjustable pointer on bushing Aiguille micrométrique	395031	395052	396096	395031	395052	-	-
DAkKS - kalibrierfähig DAkKS - calibrateable DAkKS - étalonnable	395032	395032	395032	395032	395032	395032	395032
Schweißpunktsicherung für Bajonettring Spotweld protection for bayonet ring Assurance de la baïonnette par point de soudure	395763	395763	395763	395763	-	-	-
Gebrauchslage Hochskala Normal gauge position in vertical plane Position d'utilisation verticale	-	-	-	-	-	395621	395621
Zündschutzart Intrinsic safety Sécurité intrinsèque	104101	104101	104101	104101	104101	104101	104101



Stand: 14. 09. 2018