

Einschweißschutzrohr mit Feststellschraube - mehrteilig
Weld in thermowell with fixation screw - multi part
Doigts de gant à souder avec boulon à fixerr - soudé

Form 12

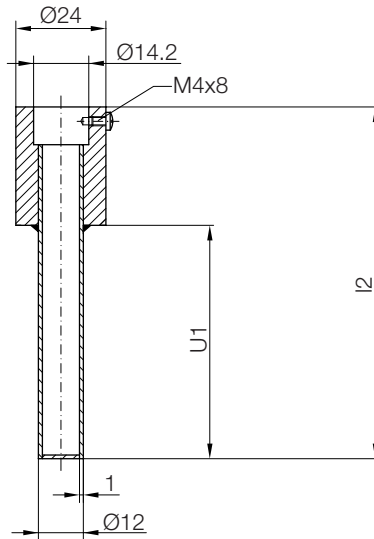

Flansch siehe Seite 12.1301 Form 1
 Flange see page 12.1301 design 1
 Bride voir page 12.1301 forme 1

Schutzrohr zum Einschweißen mit Feststellschraube Thermowell to weld in with fixation screw Doigts de gant à souder avec boulo n à fixer			
Material Material Matière	Edelstahl X6CrNiMoTi17122, Werkst.-Nr. 1.4571 Stainless steel 316Ti Acier inox Z6 CNDT 17-12		Stahl ST35, Werkst.-Nr. 1.0305 Steel A226 Acier C 10 D
Messstofftemperatur T_{max} Medium temperature T_{max} Température du fluide T_{maxi}	400 °C		300 °C
Belastung P_{max} Load P_{max} Charge P_{maxi}	40 bar		
U1	l2	Bestell-Nr. Order-N°. N° de commande	
mm			
45	76,5	410948	410943
60	91,5	417645	417646
90	121,5	415357	420208
100	131,5	410949	410944
150	181,5	410950	410945
200	231,5	410951	410946
250	281,5	410952	410947

Stand: 6. 03. 2019